

## KLT-E4MPF-OV9281 V3.0

**1MP OmniVision OV9281 Global Shutter MIPI and DVP Parallel Interface  
Fixed Focus Camera Module**



Front View



Back View

### Specifications

Camera Module No.	KLT-E4MPF-OV9281 V3.0
Resolution	1MP
Image Sensor	OV9281 Global Shutter
Sensor Type	1/4"
Pixel Size	3.0 um x 3.0 um
EFL	2.09 mm
F.NO	2.40
Pixel	1296 x 816
View Angle	146.0°(DFOV) 117.0°(HFOV) 67.0°(VFOV)
Lens Dimensions	8.00 x 8.00 x 13.52 mm
Module Size	120.00 x 10.00 mm
Module Type	Fixed Focus
Interface	MIPI and DVP Parallel
Auto Focus VCM Driver IC	None
Lens Model	KLT-LENS-TRC-4037J1
Lens Type	650nm IR Cut
Operating Temperature	-30°C to +85°C
Mating Connector	DF30FC-24DS-0.4V



## KLT-E4MPF-OV9281 V3.0

**1MP OmniVision OV9281 Global Shutter MIPI and DVP Parallel Interface  
Fixed Focus Camera Module**



Top View



Side View

[www.KaiLapTech.com](http://www.KaiLapTech.com)

[www.KaiLapTech.com](http://www.KaiLapTech.com)



Bottom View



Mating Connector





Lens Model: KLT-LENS-TRC-4037J1

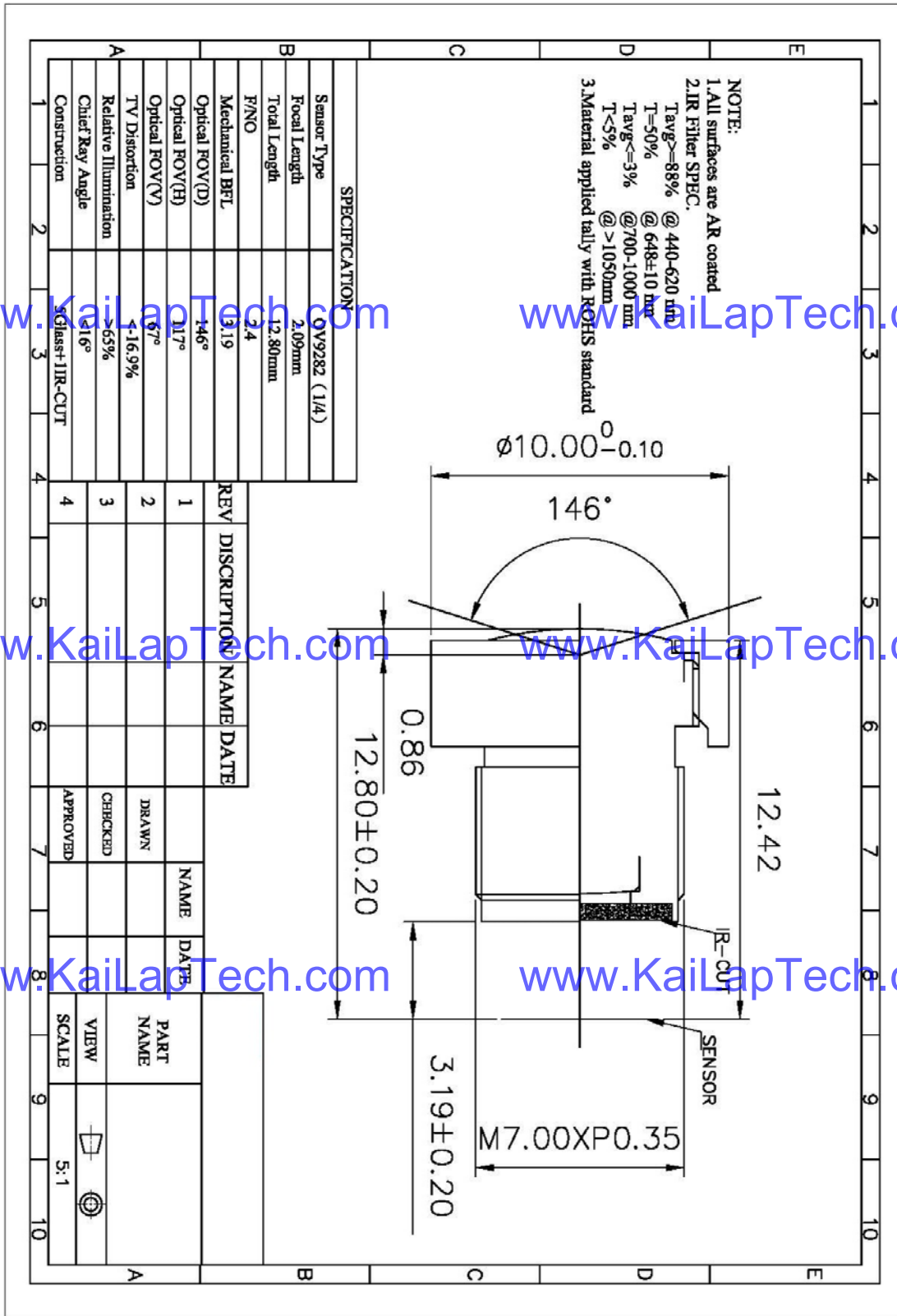

# 0.4 mm Pitch, 0.9 mm Height, Board-to-Board / Board-to-FPC Connectors

## DF30 Series

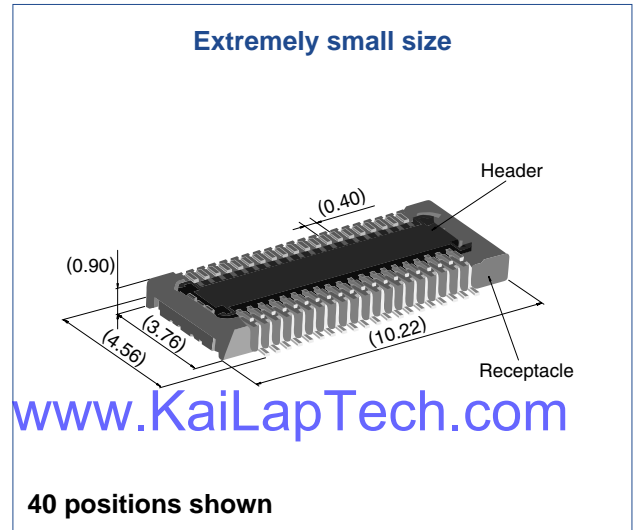
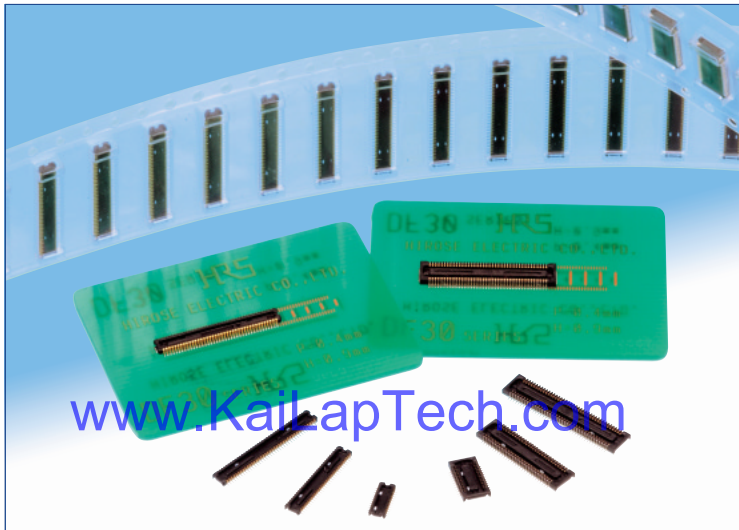

### Overview

Continuous miniaturization and increased component density on PCB created demand for extremely low profile connectors. This series is addition of a new extremely low profile connectors to Hirose's wide range of high reliability board-to-board/board-to-FPC connection solutions.

### Features

- 1. Contact reliability**  
Concentration of the contact's normal forces at the single point assures good contact wipe and electrical reliability, while confirming the fully mated condition with a definite tactile click.
- 2. Self alignment**  
Recognizing the difficulties of mating extremely small connectors in limited spaces the connectors will self align in horizontal axis within 0.3 mm.
- 3. Automatic board placement**  
Packaged on tape-and-reel the plug and headers have sufficiently large flat areas to allow pick-up with vacuum nozzles of automatic placement equipment.
- 4. Variety of contact positions and styles**  
Available in standard contact positions of: 20, 22, 24, 30, 34, 40, 50, 60, 70 and 80 with and without metal fittings. Addition of metal fittings does not affect external dimensions of the connectors. Smaller contact positions are also available.
- 5. Support for continuity test connector**  
Connectors which have increased insertion and removal durability are available for continuity tests. Contact your Hirose sales representative for details.

### Applications

Cellular phones, PDA's, mobile computers, digital cameras, digital video cameras, and other devices demanding high reliability connections in extremely limited spaces.

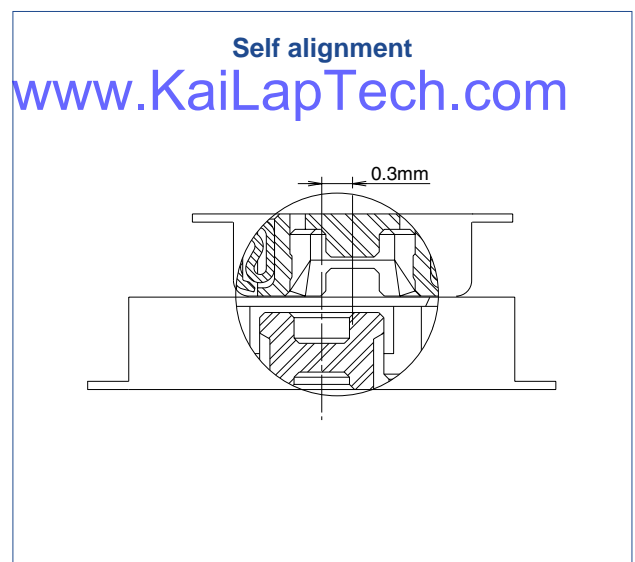
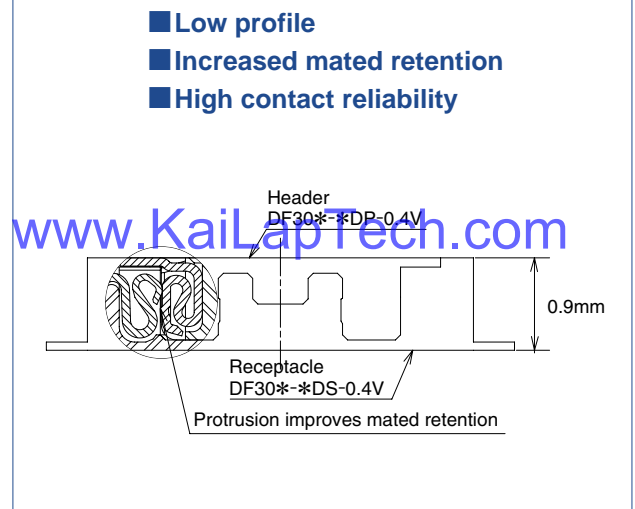

## Product Specifications

Rating	Rated current 0.3A Rated voltage 30V AC	Operating temperature range : -35°C to 85°C (Note 1) Operating humidity range : Relative humidity 20% to 80%	Storage temperature range -10°C to 60°C (Note 2) Storage humidity range Relative humidity 40% to 70% (Note 2)
--------	--	---	--

Item	Specification	Conditions
1. Insulation resistance	50 MΩ min.	100V DC
2. Withstanding voltage	No flashover or insulation breakdown.	100V AC / one minute
3. Contact resistance	100 mΩ max.	100 mA
4. Vibration	No electrical discontinuity of 1 μs or more	Frequency: 10 to 55 Hz, single amplitude of 0.75mm, 2 hours, 3 axis
5. Humidity	Contact resistance: 100 mΩ max. Insulation resistance: 25 MΩ min.	96 hours at temperature of 40°C±2°C and RH of 90% to 95%
6. Temperature cycle	Contact resistance: 100 mΩ max. Insulation resistance: 50 MΩ min.	Temperature: -55°C→+5°C to +35°C→+85°C→+5°C to +35°C Duration: 30→10→30→10(Minutes) 5 cycles
7. Durability (insertions/withdrawals)	Contact resistance: 100 mΩ max.	50 cycles (Connector for conductivity tests: 500 cycles)
8. Resistance to soldering heat	No deformation of components affecting performance.	Reflow: At the recommended temperature profile Manual soldering: 300°C for 3 seconds

Note 1: Includes temperature rise caused by current flow.

Note 2: The term "storage" refers to products stored for long period of time prior to mounting and use. Operating temperature range and humidity range covers non-conducting condition of installed connectors in storage, shipment or during transportation.

## Materials and Finishes

Connectors	Component	Material	Finish	Remarks
Receptacles and Headers	Insulator	LCP	Color : Black	UL94V-0
	Contacts	Phosphor bronze	Gold plated	
	Metal fittings	Phosphor bronze	Tin-copper plated	

## Ordering information

### ● Receptacles and Headers

DF30 FC - \* DS - 0.4 V (\*\*)

1 2 3 4 5 6 7

① Series name: DF30	⑤ Contact pitch: 0.4 mm
② Configuration FB: With metal fittings, without bosses FC: Without metal fittings, without bosses CJ: Connector for conductivity tests	⑥ Termination section V: Straight SMT
③ Number of positions: 20, 22, 24, 30, 34, 40, 50, 60, 70, 80	⑦ Packaging (81): Embossed tape packaging (5,000 pieces per reel) (82): Embossed tape packaging (1,000 pieces per reel)
④ Connector type DS: Double row receptacle DP: Double row header	

## ■ Receptacles (without metal fittings)

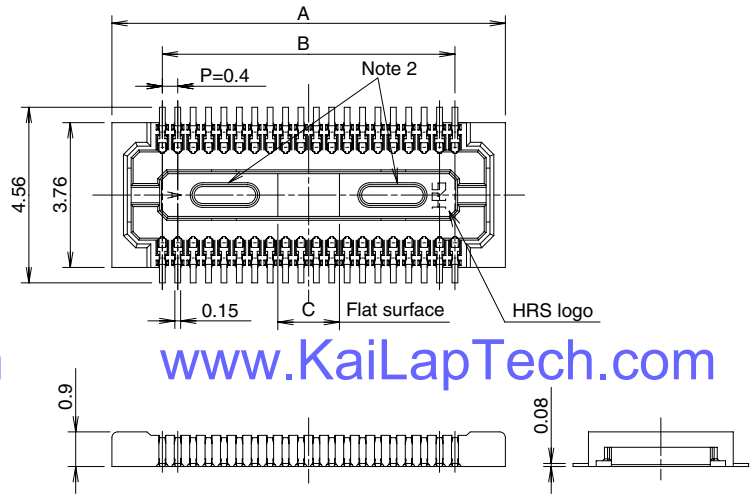
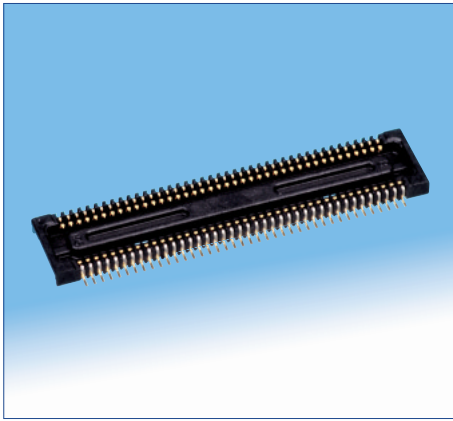

[www.KaiLapTech.com](http://www.KaiLapTech.com)

[www.KaiLapTech.com](http://www.KaiLapTech.com)

## ◆ Recommended PCB mounting pattern

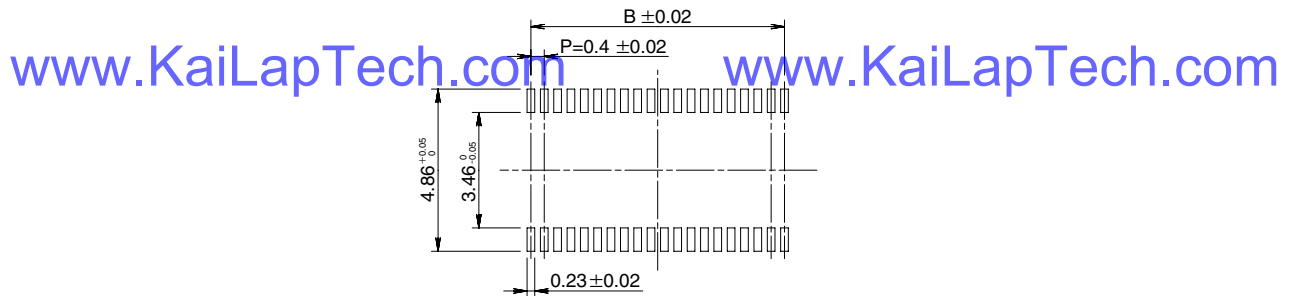

Recommended solder paste thickness: 120  $\mu$ m

[www.KaiLapTech.com](http://www.KaiLapTech.com) [Specification number] -\*\*, (\*\*)  
 (81): Embossed tape packaging (5 000 pieces per reel) [www.KaiLapTech.com](http://www.KaiLapTech.com)

\* Tolerances non- accumulative.

Unit: mm

Part Number	CL No.	Number of contacts	A	B	C
DF30FC-20DS-0.4V(**)	CL684-1109-8-**	20	6.22	3.6	1.2
DF30FC-22DS-0.4V(**)	CL684-1110-7-**	22	6.62	4.0	1.2
DF30FC-24DS-0.4V(**)	CL684-1111-0-**	24	7.02	4.4	1.2
DF30FC-30DS-0.4V(**)	CL684-1112-2-**	30	8.22	5.6	1.2
DF30FC-34DS-0.4V(**)	CL684-1113-5-**	34	9.02	6.4	1.36
DF30FC-40DS-0.4V(**)	CL684-1078-6-**	40	10.22	7.6	1.6
DF30FC-50DS-0.4V(**)	CL684-1114-8-**	50	12.22	9.6	2.0
DF30FC-60DS-0.4V(**)	CL684-1082-3-**	60	14.22	11.6	2.4
DF30FC-70DS-0.4V(**)	CL684-1115-0-**	70	16.22	13.6	2.8
DF30FC-80DS-0.4V(**)	CL684-1116-3-**	80	18.22	15.6	3.2

Note 1: Order by number of reels.

Note 2: Receptacles with 24 or fewer contacts positions will not have recessed areas.

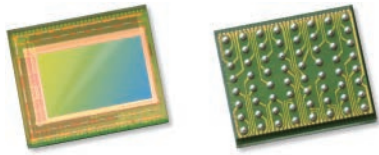

# OV9281-OV9282 1-megapixel product brief



## 1-Megapixel OmniPixel®3-GS Sensors for Computer Vision Applications



available in  
a lead free  
package

www.KaiLapTech.com

OmniVision's OV9281 and OV9282 are high-speed global shutter image sensors that bring 1-megapixel resolution to a wide range of consumer and industrial computer vision applications, including augmented reality (AR), virtual reality (VR), collision avoidance in drones, bar code scanning and factory automation. Built on OmniVision's OmniPixel®3-GS pixel technology, the OV9281 and OV9282 feature a high-speed global shutter pixel with best-in-class near-infrared (NIR) quantum efficiency (QE) to meet high-resolution and low-latency requirements.

Special features of the OV9281 and OV9282 include region of interest (ROI) selection and context switching. This allows some of the camera settings to change dynamically as fast as alternating frames. The sensors are available in both narrow and wide chief ray angle (CRA) settings.

www.KaiLapTech.com

The 1/4-inch OV9281 and OV9282 capture 1280 x 800 resolution images at 120 frames per second (fps) and VGA resolution at 180 fps with 2-lane MIPI and DVP output. The OV9281 and OV9282 also feature support for frame synchronization and dynamic defective pixel correction.

The OV9281 has a chief ray angle (CRA) of 9 degrees and comes in a chip scale package (CSP). The OV9282 features a CRA of 27 degrees and is available in a reconstructed wafer (RW) format. Both sensors are currently available in volume production.

Find out more at [www.ovt.com](http://www.ovt.com).





## Applications

- Consumer HMD
- Drones
- Machine Vision
- PCNB

## Product Features

- 3  $\mu\text{m}$  x 3  $\mu\text{m}$  pixel with OmniPixel<sup>3</sup>-GS technology
- automatic black level calibration (ABLC)
- programmable controls for:
  - frame rate
  - mirror and flip
  - cropping
  - windowing
- support output formats: 8/10-bit RAW
- fast modeswitching
- supports 2x2 monochrome binning
- two-lane MIPI serial output interface
- DVP parallel output interface
- supports horizontal and vertical 2:1 and 4:1 monochrome subsampling
- support for image sizes:
  - 1280 x 800
  - 1280 x 720
  - 640 x 480
  - 640 x 400
- embedded 256 bits of one-time programmable (OTP) memory for part identification
- two on-chip phase lock loops (PLLs)
- LED PWM
- built-in strobe control

# OV9281-OV9282

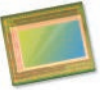

## Ordering Information

- **OV9281-H64A**  
(b&w, lead-free) 64-pin CSP
- **OV9282-GA4A**  
(b&w, lead-free, 200  $\mu\text{m}$  backgrinding, reconstructed wafer with good die)

## Technical Specifications

- **active array size:** 1296 x 816
- **maximum image transfer rate:**  
- 1280 x 800: 120 fps
- **power supply:**
  - analog: 2.8V (nominal)
  - core: 1.2V (nominal)
  - I/O: 1.8V (nominal)
- **power requirements:**
  - active: 156 mW
  - standby: 150  $\mu\text{A}$
  - XSHUTDOWN: 150  $\mu\text{A}$
- **temperature range:**
  - operating: -30°C to +85°C junction temperature
  - stable image: 0°C to +50°C junction temperature
- **output interfaces:** 2-lane MIPI serial output and DVP parallel output
- **output formats:** 8/10-bit RAW
- **lens size:** 1/4"
- **lens chief ray angle:**
  - OV9281: 9° linear
  - OV9282: 26.78° non-linear
- **scan mode:** progressive
- **pixel size:** 3  $\mu\text{m}$  x 3  $\mu\text{m}$
- **image area:** 3896  $\mu\text{m}$  x 2453  $\mu\text{m}$

## Functional Block Diagram

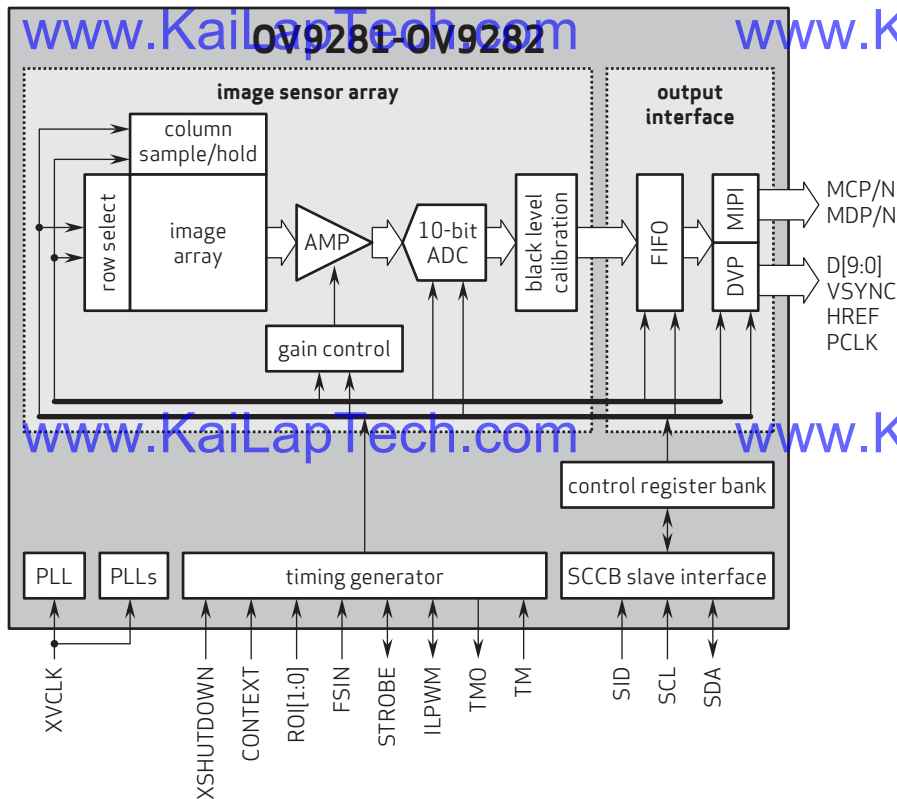

4275 Burton Drive  
Santa Clara, CA 95054  
USA

Tel: + 1 408 567 3000  
Fax: + 1 408 567 3001  
www.ovt.com

OmniVision reserves the right to make changes to their products or to discontinue any product or service without further notice. OmniVision, the OmniVision logo and OmniPixel are registered trademarks of OmniVision Technologies, Inc. All other trademarks are the property of their respective owners.



OmniVision



## Camera Module Pinout Definition Reference Chart

OmniVision	Sony	Samsung	On-Semi	Aptina	Himax	GalaxyCore	PixArt	SmartSens	Sensors
Pin Signal		Description							
DGND GND		ground for digital circuit							
AGND		ground for analog circuit							
PCLK DCK		DVP PCLK output							
XCLR PWDN XSHUTDOWN STANDBY		power down active high with internal pull-down resistor							
MCLK XVCLK XCLK INCK		system input clock							
RESET RST		reset active low with internal pull-up resistor							
NC NULL		no connect							
SDA SIO_D SIOD		SCCB data							
SCL SIO_C SIOC		SCCB input clock							
VSYNC XVS FSYNC		DVP VSYNC output							
HREF XHS		DVP HREF output							
DOVDD		power for I/O circuit							
AFVDD		power for VCM circuit							
AVDD		power for analog circuit							
DVDD		power for digital circuit							
STROBE FSTROBE		strobe output							
FSIN		synchronize the VSYNC signal from the other sensor							
SID		SCCB last bit ID input							
ILPWM		mechanical shutter output indicator							
FREQ		frame exposure / mechanical shutter							
GPIO		general purpose inputs							
SLASEL		I2C slave address select							
AFEN		CEN chip enable active high on VCM driver IC							
<b>MIPI Interface</b>									
MDN0 DN0 MD0N DATA_N DMO1N		MIPI 1st data lane negative output							
MDP0 DP0 MD0P DATA_P DMO1P		MIPI 1st data lane positive output							
MDN1 DN1 MD1N DATA2_N DMO2N		MIPI 2nd data lane negative output							
MDP1 DP1 MD1P DATA2_P DMO2P		MIPI 2nd data lane positive output							
MDN2 DN2 MD2N DATA3_N DMO3N		MIPI 3rd data lane negative output							
MDP2 DP2 MD2P DATA3_P DMO3P		MIPI 3rd data lane positive output							
MDN3 DN3 MD3N DATA4_N DMO4N		MIPI 4th data lane negative output							
MDP3 DP3 MD3P DATA4_P DMO4P		MIPI 4th data lane positive output							
MCN CLKN CLK_N DCKN		MIPI clock negative output							
MCP CLKP MCP CLK_P DCKN		MIPI clock positive output							
<b>DVP Parallel Interface</b>									
D0 DO0 Y0		DVP data output port 0							
D1 DO1 Y1		DVP data output port 1							
D2 DO2 Y2		DVP data output port 2							
D3 DO3 Y3		DVP data output port 3							
D4 DO4 Y4		DVP data output port 4							
D5 DO5 Y5		DVP data output port 5							
D6 DO6 Y6		DVP data output port 6							
D7 DO7 Y7		DVP data output port 7							
D8 DO8 Y8		DVP data output port 8							
D9 DO9 Y9		DVP data output port 9							
D10 DO10 Y10		DVP data output port 10							
D11 DO11 Y11		DVP data output port 11							



your **BEST** camera module partner

## Cameras Applications



[www.KaiLapTech.com](http://www.KaiLapTech.com)



[www.KaiLapTech.com](http://www.KaiLapTech.com)



[www.KaiLapTech.com](http://www.KaiLapTech.com)

[www.KaiLapTech.com](http://www.KaiLapTech.com)



[www.KaiLapTech.com](http://www.KaiLapTech.com)



[www.KaiLapTech.com](http://www.KaiLapTech.com)





## Camera Reliability Test

Reliability Inspection Item		Testing Method	Acceptance Criteria	
Category	Item			
Environmental	Storage Temperature	High 60°C 96 Hours	Temperature Chamber	No Abnormal Situation
		Low -20°C 96 Hours	Temperature Chamber	No Abnormal Situation
	Operation Temperature	High 60°C 24 Hours	Temperature Chamber	No Abnormal Situation
		Low -20°C 24 Hours	Temperature Chamber	No Abnormal Situation
	Humidity	60°C 80% 24 Hours	Temperature Chamber	No Abnormal Situation
	Thermal Shock	High 60°C 0.5 Hours Low -20°C 0.5 Hours Cycling in 24 Hours	Temperature Chamber	No Abnormal Situation
Physical	Drop Test (Free Falling)	Without Package 60cm	10 Times on Wood Floor	Electrically Functional
		With Package 60cm	10 Times on Wood Floor	Electrically Functional
	Vibration Test	50Hz X-Axis 2mm 30min	Vibration Table	Electrically Functional
		50Hz Y-Axis 2mm 30min	Vibration Table	Electrically Functional
		50Hz Z-Axis 2mm 30min	Vibration Table	Electrically Functional
Cable Tensile Strength Test	Loading Weight 4 kg 60 Seconds Cycling in 24 Hours	Tensile Testing Machine	Electrically Functional	
Electrical	ESD Test	Contact Discharge 2 KV	ESD Testing Machine	Electrically Functional
		Air Discharge 4 KV	ESD Testing Machine	Electrically Functional
	Aging Test	On/Off 30 Seconds Cycling in 24 Hours	Power Switch	Electrically Functional
	USB Connector	On/Off 250 Times	Plug and Unplug	Electrically Functional





Inspection Item		Inspection Method	Standard of Inspection	
Category	Item			
Appearance	FPC/ PCB	Color	The Naked Eye	Major Difference is Not Allowed.
		Be Torn/Chopped	The Naked Eye	Copper Crack Exposure is Not Allowed.
		Marking	The Naked Eye	Clear, Recognizable (Within 30cm Distance)
	Holder	Scratches	The Naked Eye	The Inside Crack Exposure is Not Allowed
		Gap	The Naked Eye	Meet the Height Standard
		Screw	The Naked Eye	Make Sure Screws Are Presented (If Any)
		Damage	The Naked Eye	The Inside Crack Exposure is Not Allowed
	Lens	Scratch	The Naked Eye	No Effect On Resolution Standard
		Contamination	The Naked Eye	No Effect On Resolution Standard
		Oil Film	The Naked Eye	No Effect On Resolution Standard
		Cover Tape	The Naked Eye	No Issue On Appearance.
	Function	Image	No Communication	Test Board
Bright Pixel			Black Board	Not Allowed In the Image Center
Dark Pixel			White board	Not Allowed In the Image Center
Blurry			The Naked Eye	Not Allowed
No Image			The Naked Eye	Not Allowed
Vertical Line			The Naked Eye	Not Allowed
Horizontal Line			The Naked Eye	Not Allowed
Light Leakage			The Naked Eye	Not Allowed
Blinking Image			The Naked Eye	Not Allowed
Bruise			Inspection Jig	Not Allowed
Resolution			Chart	Follows Outgoing Inspection Chart Standard
Color			The Naked Eye	No Issue
Noise			The Naked Eye	Not Allowed
Corner Dark			The Naked Eye	Less Than 100px By 100px
Color Resolution			The Naked Eye	No Issue
Dimension	Height	The Naked Eye	Follows Approval Data Sheet	
	Width	The Naked Eye	Follows Approval Data Sheet	
	Length	The Naked Eye	Follows Approval Data Sheet	
	Overall	The Naked Eye	Follows Approval Data Sheet	



## KLT Package Solutions

KLT Camera Module

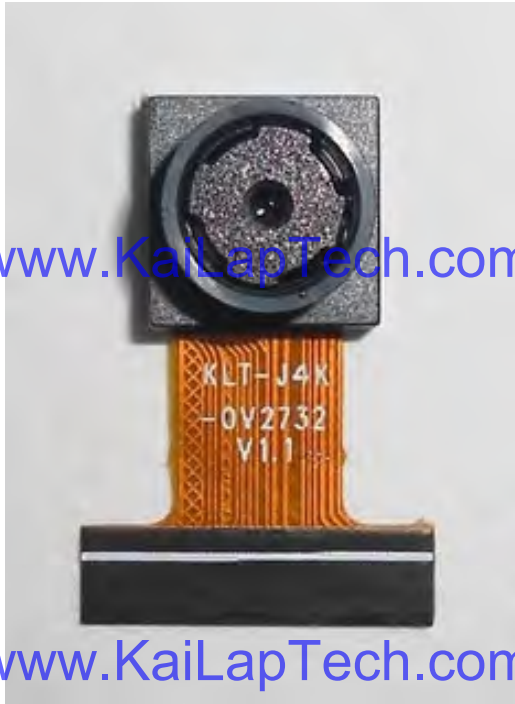

Complete with Lens Protection Film



Tray with Grid and Space



Place Cameras on the Tray





## Camera Modules Package Solution

Full Tray of Cameras



Cover Tray with Lid



Put Tray into Anti-Static Bag



Vacuum the Anti-Static Bag

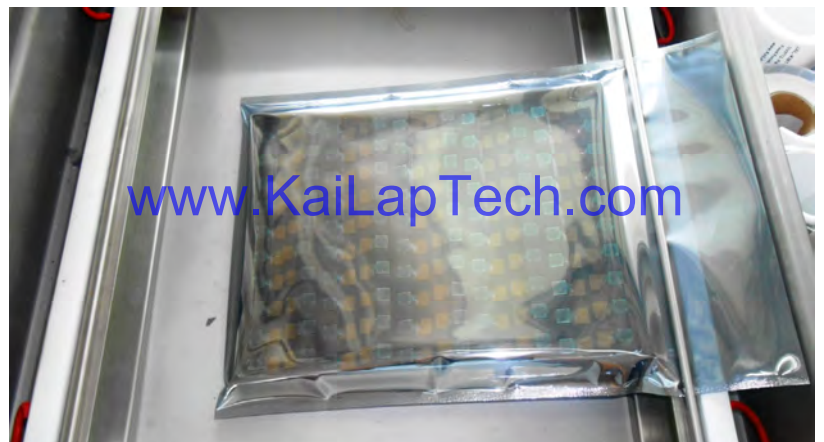



## Camera Modules Package Solution

**Sealed Vacuum Bag with Labels**

- 1. Model and Description 2. Quantity 3. Shipping Date 4. Caution**







# CMOS CAMERA MODULES



*your BEST camera module partner*

## Large Order Package Solution

Place Foam Sheets Between Trays

Foam Sheets are Slightly Larger than Trays



[www.KaiLapTech.com](http://www.KaiLapTech.com)

[www.KaiLapTech.com](http://www.KaiLapTech.com)

Place Foam Sheets and Trays into Box

Foam Sheets are Tightly Fitting Box

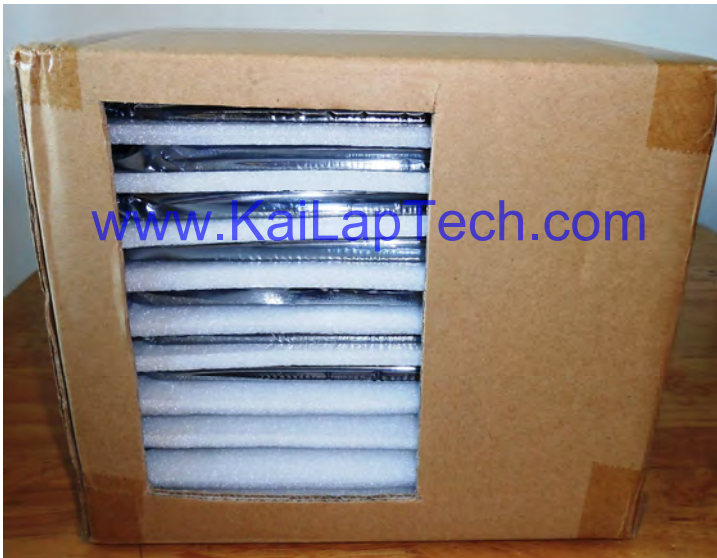

[www.KaiLapTech.com](http://www.KaiLapTech.com) [sales@KaiLapTech.com](mailto:sales@KaiLapTech.com) Tel: (852) 6908 1256 Fax: (852) 3017 6778

All rights reserved @ Kai Lap Technologies Group Ltd. Specifications subject to change without notice.



# CMOS CAMERA MODULES



*your BEST camera module partner*

## Small Order Package Solution

Place Foam Sheets and Trays into Small Box



[www.KaiLapTech.com](http://www.KaiLapTech.com)

[www.KaiLapTech.com](http://www.KaiLapTech.com)

Package in Small Box for Shipment

Foam Sheets are Nicely Fitting the Small Box



[www.KaiLapTech.com](http://www.KaiLapTech.com)

[www.KaiLapTech.com](http://www.KaiLapTech.com)

Place Small Boxes into Larger Box



[www.KaiLapTech.com](http://www.KaiLapTech.com)



[www.KaiLapTech.com](http://www.KaiLapTech.com)



## Carbon Box Package Solution

Seal the Carbon Box

Final Package Labelled Box



### Carbon Box Ready for Shipment

1. Delivery Address and Phone No.
2. Box No. and Ship Date
3. Fragile Caution





## Sample Order Package Solution

Place Sample into Small Anti-Static Bag



Place Connectors into Small Ant-Static Bag



### Sample Labels on the Small Bag

1. Camera Module or Connector Model 2. Shipping Date and Quantity 3. Caution





## Connectors Large Order Package Solution

Connectors in a Wheel



Label Connectors in the Wheel



The Wheel is Perfectly Fitting the Box



Connectors Box Ready for Shipment



## Company Kai Lap Technologies (KLT)

Kai Lap Technologies Group Limited. (KLT) was established in 2009, a next-generation technology driven manufacturer specialized in research, design, and produce of audio and video products. KLT is occupying 20,000 square feet automated plants with 100 employees of annual throughput 30,000,000 units cameras.

KLT provides OEM, ODM design, contract manufacturing, and builds the camera products. You may provide the requirements to us, even with a hand draft, our sales and engineering work together to meet your needs. We consider ourselves your last-term partner in developing practical and innovative solutions.

Our team covers everything from initial concept development to mass produced product. KLT specializes in customized camera design, raw material, electronic engineering, firmware/software development, product testing, and packing design. Our experienced strategic supply systems offer a robust and dependable manufacturing capacity for orders of various sizes.

[www.KaiLapTech.com](http://www.KaiLapTech.com)

[www.KaiLapTech.com](http://www.KaiLapTech.com)



## Limited Warranty

KLT provides the following limited warranty if you purchased the Product(s) directly from KLT company or from KLT's website, [www.KaiLapTech.com](http://www.KaiLapTech.com). Product(s) purchased from other sellers or sources are not covered by this Limited Warranty. KLT guarantees that the Product(s) will be free from defects in materials and workmanship under normal use for a period of one (1) year from the date you receive the product ("Warranty Period").

For all Product(s) that contain or develop material defects in materials or workmanship during the Warranty Period, KLT will, at its sole option, either: (i) repair the Product(s); (ii) replace the Product(s) with a new or refurbished Product(s) (replacement Product(s) being of identical model or functional equivalent); or (iii) provide you a refund of the price you paid for the Product(s).

This Limited Warranty of KLT is solely limited to repair and/or replacement on the terms set forth above. KLT is not reliable or responsible for any subsequent events.





# CMOS CAMERA MODULES



*your BEST camera module partner*

## KLT Strength

### Powerful Factory



### Professional Service



### Promised Delivery



[www.KaiLapTech.com](http://www.KaiLapTech.com) [sales@KaiLapTech.com](mailto:sales@KaiLapTech.com) Tel: (852) 6908 1256 Fax: (852) 3017 6778

All rights reserved @ Kai Lap Technologies Group Ltd. Specifications subject to change without notice.